

tacoPrep Bead Beater

User Manual

Manufacturer:

GeneReach Biotechnology Corporation

TEL: 886-4-2463-9869

Email: sales@genereach.com









No. 19, Keyuan 2nd Rd., Central Taiwan Science Park, Taichung City 407, Taiwan

Website: www.tacomag.com

Content

Symbols.....	1
1 Introduction.....	2
1.1 Intended Use.....	2
1.2 tacoPrep Specifications.....	2
1.3 Product Overview.....	3
1.4 Safety Information.....	4
1.5 Warranty.....	5
2 Installation.....	5
2.1 Unpacking.....	5
2.2 Equipments and Materials Required But Not Provides.....	5
3 Operation Procedure.....	6
3.1 Switching On.....	6
3.2 Setting Up.....	7
3.3 Starting/Stopping Homogenization.....	8
3.4 Switching Off.....	8
4 Cleaning and Maintenance.....	9
4.1 General Care.....	9
4.2 Dealing with Spills.....	9
5 Troubleshooting.....	10

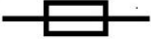
Symbols

	Date of manufacturing	
	Manufacturer	
	Catalogue number	
	Serial number	
	Alternative current	
	Consult instruction before use	
	Supplementary Fuse	
	Caution	Risk of personal injury to the operator or a safety hazard to the surrounding area.
	WEEE symbol	This product is required to comply with the European Union's Waste Electrical & Electronic Equipment (WEEE) Directive 2002/96/EC.

1 Introduction

The **tacoPrep Bead Beater** is designed to homogenize up to 16 biological samples simultaneously for releasing cellular contents. Animal and plant tissues could be disrupted within a short period of time through contacting with highly accelerated beads.

1.1 Intended Use

The **tacoPrep Bead Beater** is intended to disrupt biological samples with beads. The homogenates could be applied directly to **taco™ Nucleic Acid Automatic Extraction System** for nucleic acid extraction, or for other downstream research applications.

1.2 tacoPrep Specifications

Length	300 mm
Width	250 mm
Height	240 mm
Net weight	11 kg
Power requirements	100-120/200-240 V AC, 50/60 Hz, 2A
Operating temperature	16 - 30 °C
Capacity	1 - 16
Cycle duration	Cycle 1 - 6 : 13 sec/cycle Cycle E1 - E6 : 40 sec/cycle

1.3 Product Overview

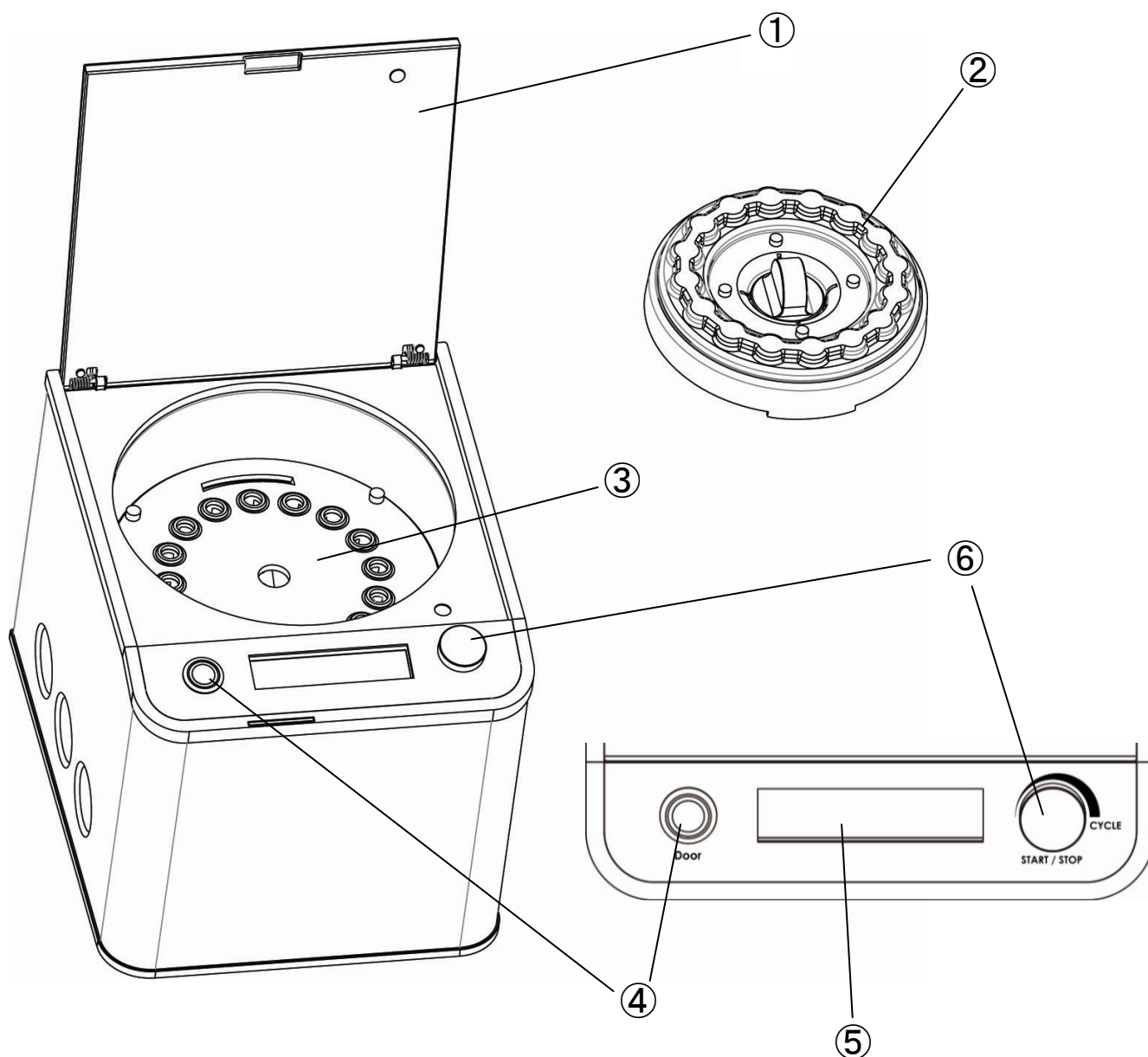

No	Item	Description
1	Door	Door
2	Holder Lid	To prevent the beating tubes from ejecting out
3	Tube Holder	To hold beating tubes for reaction
4	Door Button	To open the door
5	LED Screen	LED screen for showing the settings
6	Cycle Knob	To select the reaction cycle and to start / stop the cycle

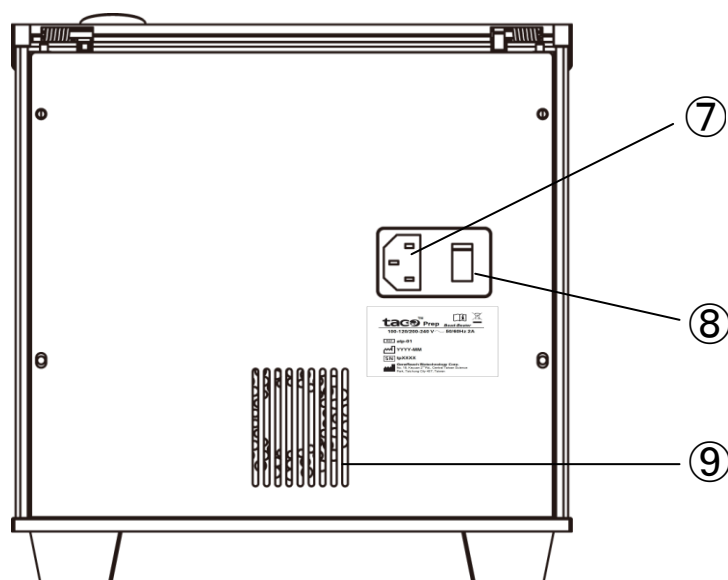

No	Item	Description
7	Socket	To connect to the power cord
8	Power Switch	To turn on/off the main power
9	Cooling Vents	For ventilation

1.4 Safety Information

- **Do not** touch any plug and electric switch with wet hands.
- **Do not** operate the unit with the safety ground disconnected.
- **Do not** transport the unit without switching off and unplugging the device
- **Do not** use unauthorized consumables and accessories not provided from GeneReach.
- **Do not** overfill the tubes as this may lead to liquid contamination and impair the safety of the unit.
- **Do not** operate the unit when the ambient temperature is out of 16-30 °C.
- **Do not** disassemble the device if any problem occurs. Contact your local distributor or GeneReach directly for troubleshooting.
- **Check** that the voltage indicated on the rear panel of the unit matches to the local power supply.
- Users should revalidate the device if it has been moved.
- When operating device, always wear a lab coat, disposable gloves, ear muffs and protective goggles.
- Ship the device with original package at room temperature.

1.5 Warranty

GeneReach Biotechnology Corp. certifies that this product is free of defects at the time of shipment. This warranty is limited to a period of one (1) year.

This warranty is not applicable in the following circumstances:

- The equipment has not been installed, operated, maintained or shipped according to the instructions described in this user manual.
- The equipment has been repaired or modified by unauthorised personnel.

2 Installation

2.1 Unpacking

Check the contents of box. It shall contain the following items:

- 1 **tacoPrep Bead Beater**
- 1 Power Cord
- 1 User Manual
- 1 Warranty Card

Should one of these items be missing, please contact **GeneReach** or your local distributors immediately.

2.2 Equipments and Materials Required But Not Provides

- 2 ml beating tube. **GeneReach tacoPrep Beating Tubes** are recommended.
- Steel, glass, or ceramic beads. **GeneReach tacoPrep Steel Beads** are recommended.



Using improper consumables may affect or damage the device performance. Non-GeneReach** consumables should be validated before use.**

3 Operation Procedure

3.1 Switching On

- Plug the **tacoPrep** into the power supply and switch on the power switch located at the back. The LED screen will show “**tacoPREP BEAD BEATER**” with a beeping sound for a few seconds.





- After starting the unit, press the “**Door**” button to open door, the screen will show “**DOOR OPEN**”.

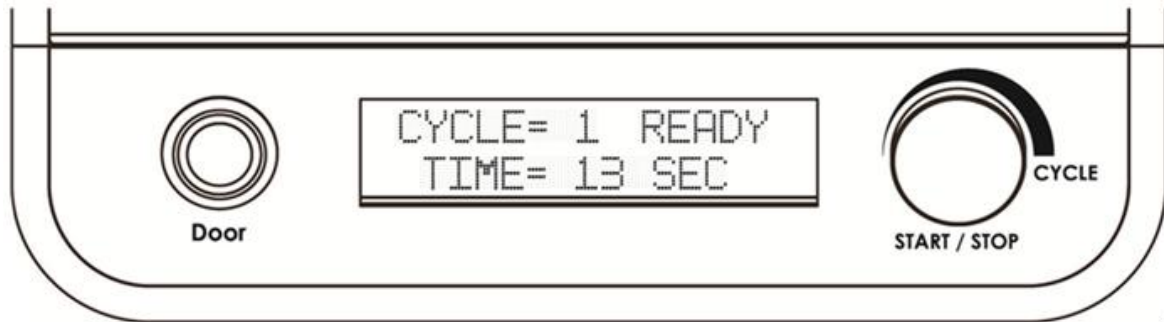

3.2 Setting Up

- Load the beating tube with appropriate beads (we recommend using six 2.5mm-diameter steel beads/tube), sample of interest and buffer (if necessary). Tightly cap the beating tube and place it into the tube holder, then fasten the holder lid and close the door. The screen will show “ **READY** ” on the top right side of the LED screen.



 **Do not use buffer which contains phenol or chloroform for homogenization.**

- Adjust the **Cycle Knob** to set up the reaction cycles. The cycle number increases when the **Cycle Knob** is turned clockwise, and decreases when the knob is turned counter-clockwise.

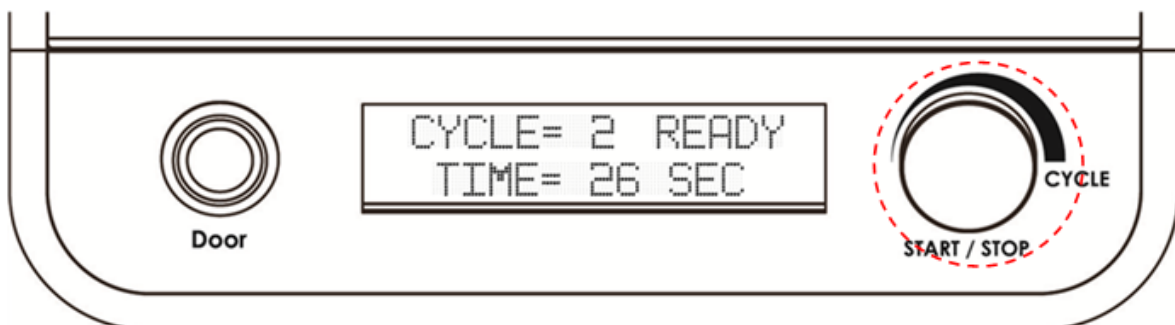

 **Make sure the holder lid is tightened securely.**

3.3 Starting/Stopping Homogenization

- Press the **Cycle Knob** to start the reaction. The remaining time will be displayed on the LED screen.

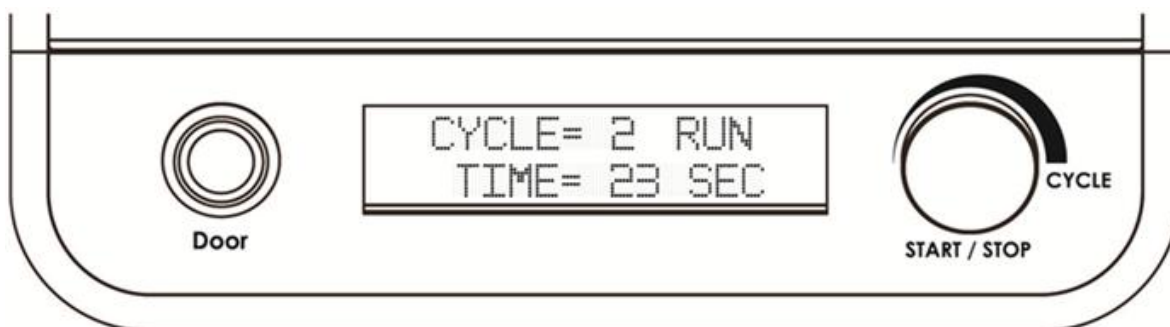

- When the homogenization is finished, or when the **Cycle Knob** is pressed again to stop the homogenization, the LED screen will show “**DONE**” at the top right side on the screen with beeping sounds for a few seconds. The door will automatically open. Unfasten the holder lid to take out the beating tubes.

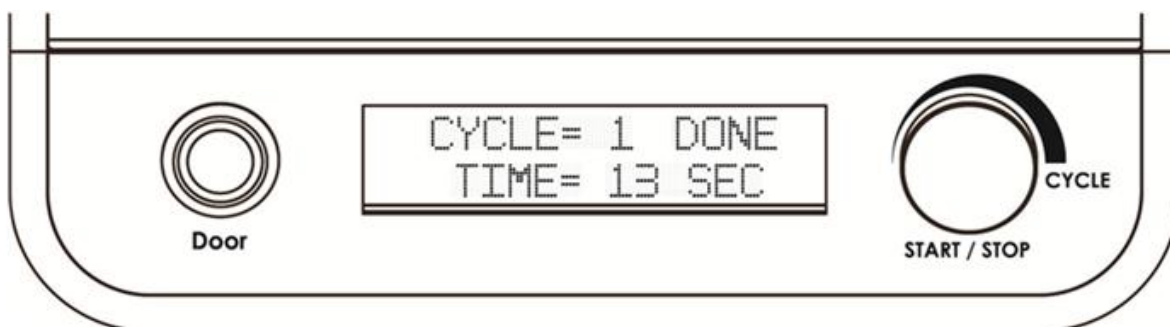

	If the sample tube is broken after the homogenization, please see troubleshooting.
--	---

	To avoid degradation, it is recommended to take out the samples immediately after the homogenization for further processing or proper storage.
--	---

3.4 Switching Off

After the homogenization reaction, turn off the power switch at the back of the unit.

4 Cleaning and Maintenance

4.1 General Care

Use only clean and wet paper towel or cotton pad to wipe out stains in the holder. Remove the 4 screws (using **M5 Hex Key**) on the surface of the tube holder to take out the tube holder and clean the inside of the unit. Do not use solvent, detergent or bleach to clean the **tacoPrep** surface.

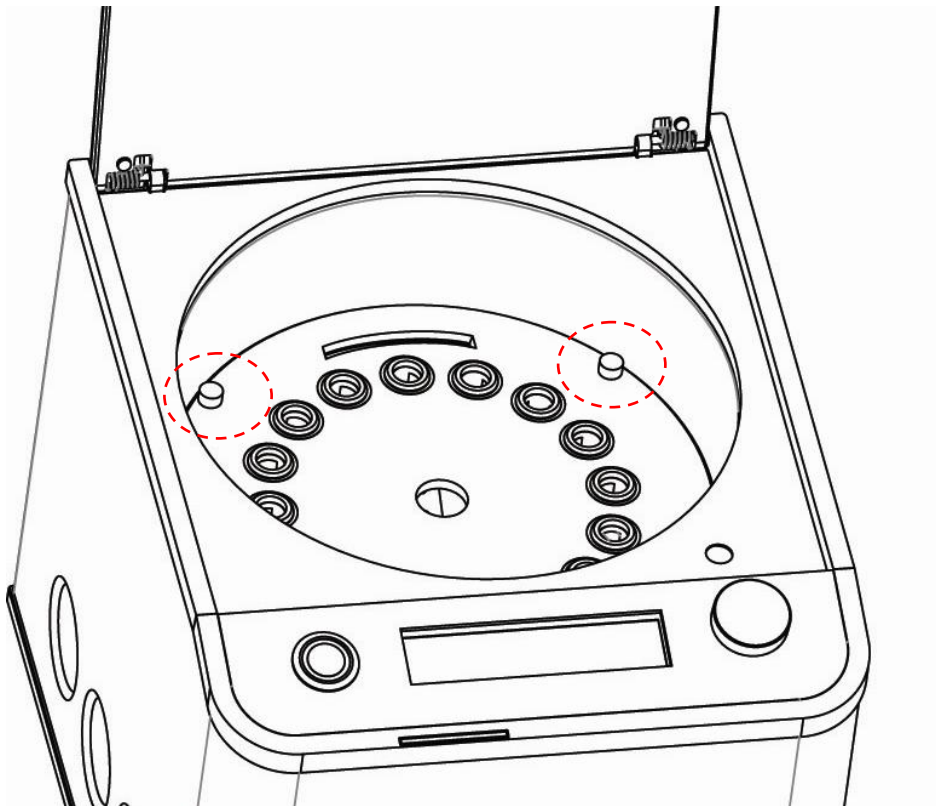

Note: Always wear gloves, and always switch off and unplug the tacoPrep before cleaning.

4.2 Dealing with Spills

Wipe out visible spills with disposable paper towel immediately, and contact your local distributor or **GeneReach** directly for assistance.

5 Troubleshooting

Observation or Problems	Comments and Suggestions
(a) The unit has no response	<ul style="list-style-type: none"> • Re-start the device. • Contact your local distributor or GeneReach for assistance.
(b) No display on the LED screen, or the screen is frozen	<ul style="list-style-type: none"> • Check the plug to see if it has been connected to the power system. • Check the fuse to see if it is overloaded. • Contact your local distributor or GeneReach for assistance.
(c) The Door button and/or the Cycle Knob is not working	<ul style="list-style-type: none"> • Check the plug to see if it has been connected to the power system. • Contact your local distributor or GeneReach for assistance.
(d) The sample tube is broken after the homogenization	<ul style="list-style-type: none"> • Check to see whether recommended beating tubes were used. • Contact your local distributor or GeneReach for assistance.
(e) The holder lid cannot be closed	<ul style="list-style-type: none"> • Contact your local distributor or GeneReach for assistance.

